

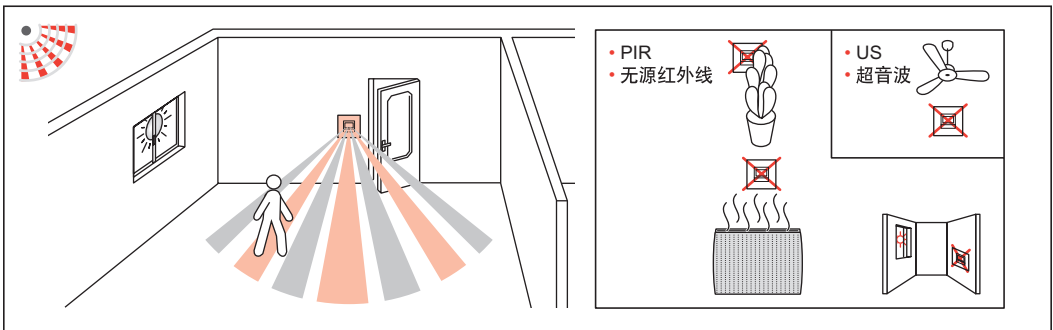

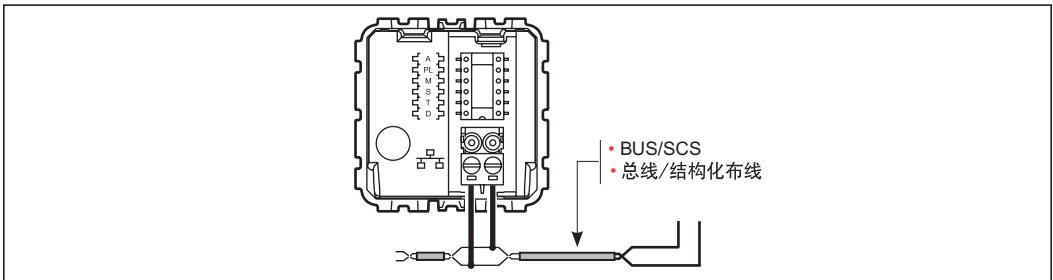

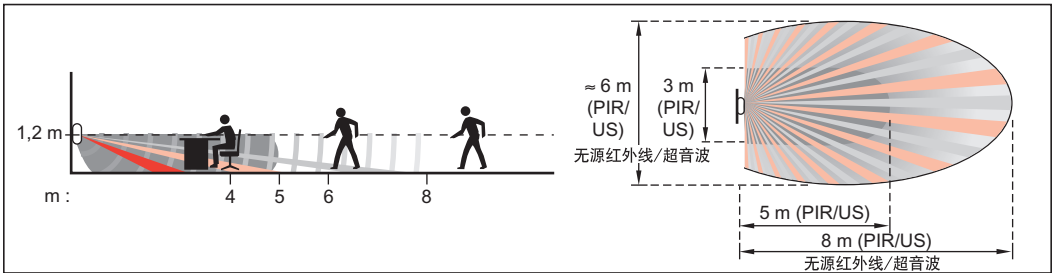

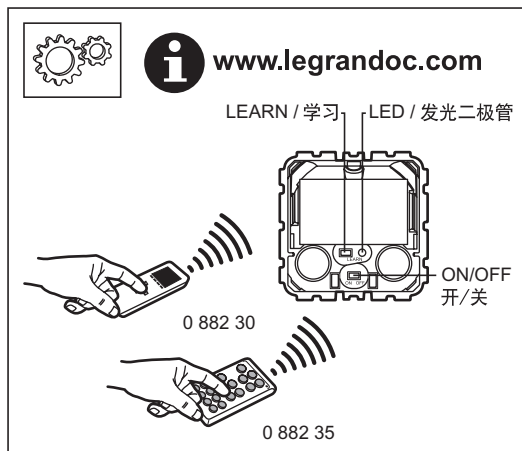
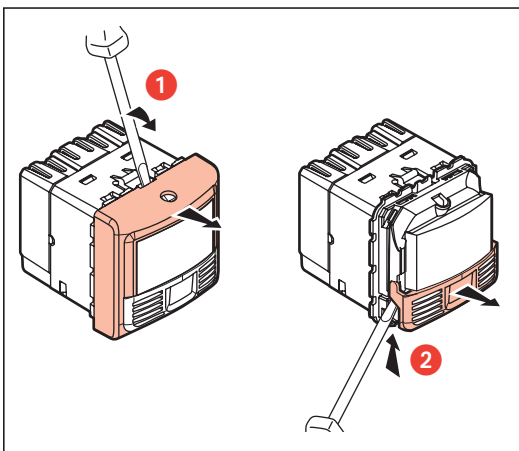
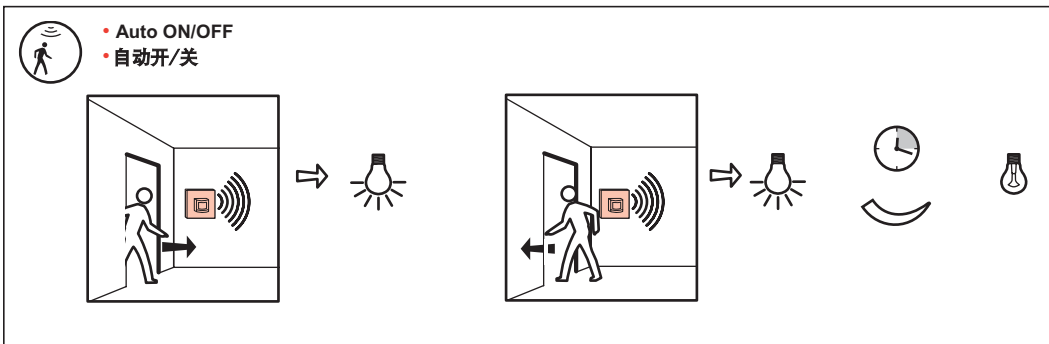
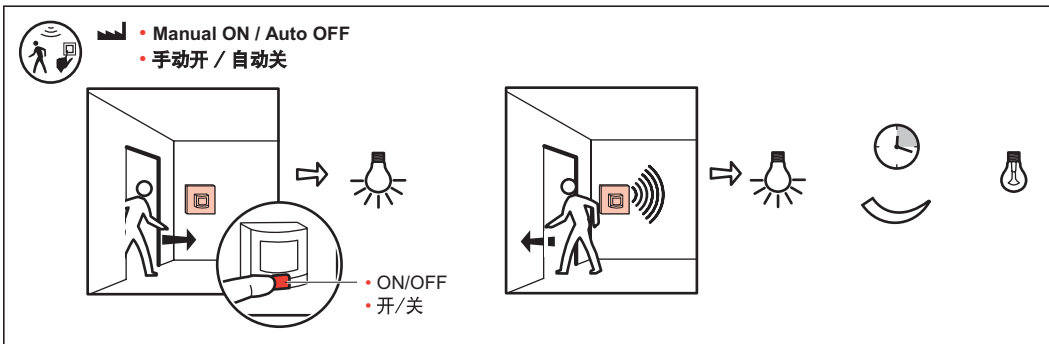
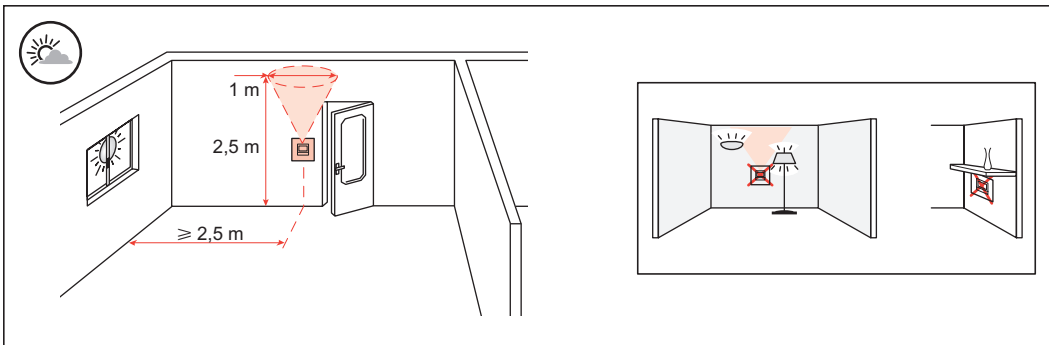

	27 V <sub>~</sub>
	20 mA
	2 x 0,35 mm <sup>2</sup>
	-5°C / +45°C
	<ul style="list-style-type: none"> <li>• PIR/US</li> <li>• 无源红外线/超音波</li> </ul>
	300 lux
	15 mn
	45 m <sup>2</sup>





	= 27 فولت
	20 ملي أمبير
	2 مم 2 x 0,35
	-5°C / +45°C
	أشعة تحت حمراء سلبية / موجات فوق صوتية
	300 لكس
	15 دقيقة
	45 م <sup>2</sup>

